

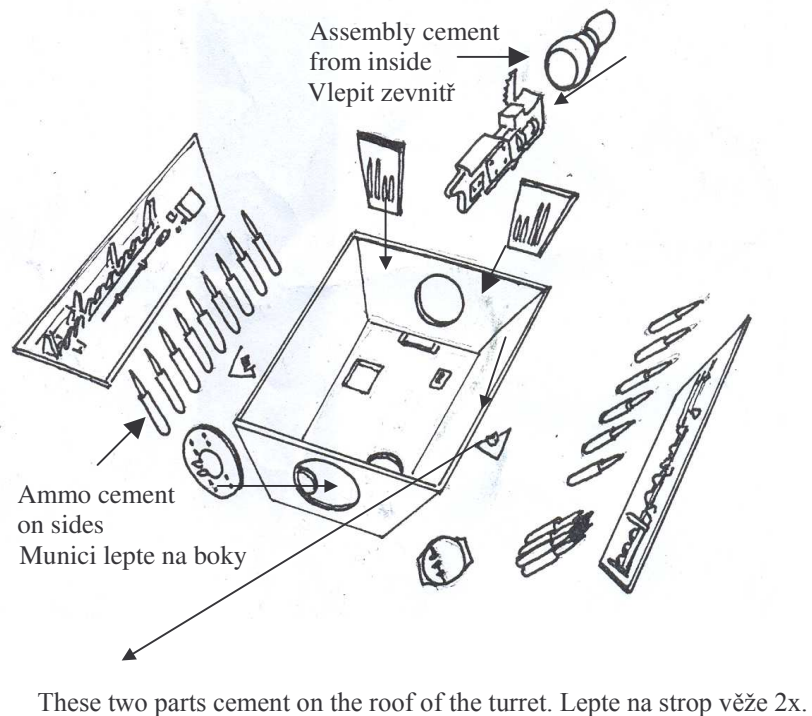

Ferdinand/Elephant interior detail set For TRUMPETER kit

Catalogue No. 9201

STEP 1 - TURRET ASSEMBLY



STEP 3 - DRIVER'S

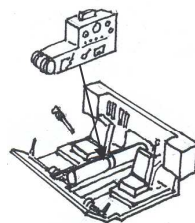

STEP 4 - MG MOUNT

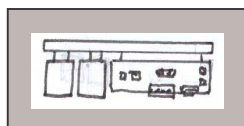
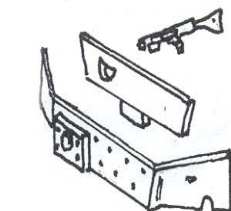

Ferdinand parts no MG

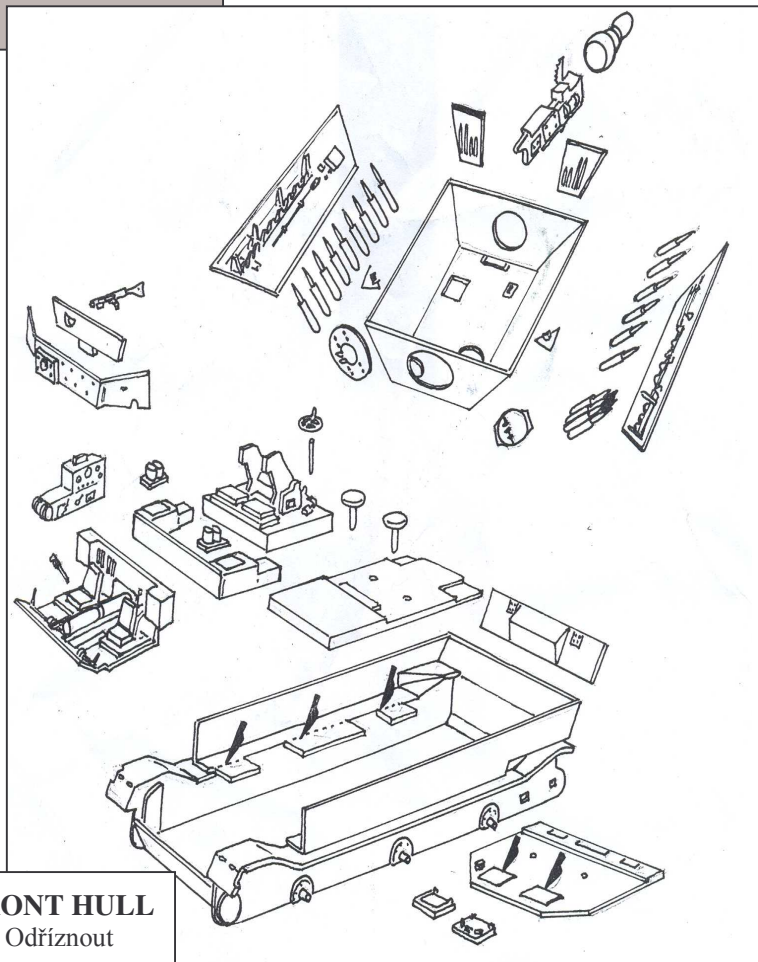

STEP 2 - BODY

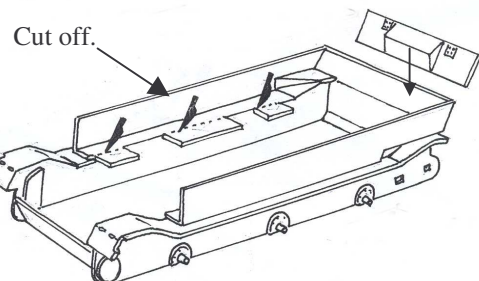

STEP 5 - COMBAT COMP.

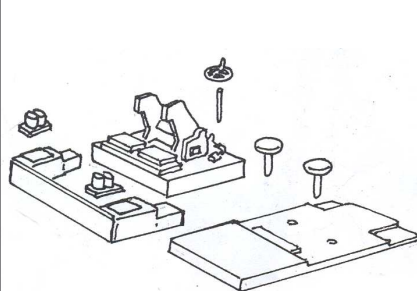

STEP 6 - FRONT HULL

Cut off / Odríznout

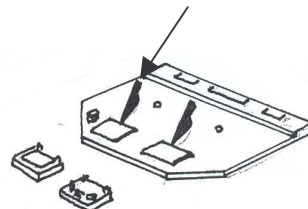

This kit is product of PROFIKIT Models
Czech Republic

For painting see box art or visit web pages
www.sweb.cz/profikit

With questions or tips contact
profikit@centrum.cz